



SPAF

since 1974



Dasa-Rägister
EN ISO 9001 (2000)
IQ-1003-04

www.spaf.it
e-mail: spaf@spaf.it

15ª EDIZIONE

AGENTE

Krzysztof Wolicki

0 604-286-073

Biuro 22 226-03-21

biuro@krzysztof.waw.pl



Dasa-Rägister

IQ-1003-04

Certificato NO.
Certificate NO.

2003-10-08

Data di prima emissione
First issue date

2009-04-07

Data di ultima emissione
Last issue date

2010-11-16

Data di scadenza
Entry date

President & C.E.

President & C.E.

Dasa-Rägister S.p.A.
Italy - 00140 Formosa - Roma
Via dei Costoli Romani, 22
Tel. +39 0691622002
Fax +39 069107126
www.dasa-raegister.com
Offices: Milano, Roma, Bari

SINCERT

ISO 9001:2000 CERTIFICATION

ISO 9001:2000
Member of the Council of European Certification Bodies

Dasa-Rägister S.p.A.

ENTE CERTIFICATORE CERTIFICA CHE IL SISTEMA DI GESTIONE PER LA QUALITÀ DI
CERTIFICATION BODY CERTIFIES THAT THE QUALITY MANAGEMENT SYSTEM OF

S.P.A.F. S.a.s.

Italia - 10022 Carmagnola (Torino) - Via Chieri, 66

È STATO VERIFICATO E TROVATO CONFORME AI REQUISITI DELLO STANDARD
HAS BEEN ASSESSED AND FOUND IN COMPLIANCE WITH THE STANDARD REQUIREMENTS

EN ISO 9001:2000

Per le seguenti attività aventi come oggetto
Produzione e commercializzazione all'ingrosso di articoli funebri

For the following activities having as object
Production and wholesale trade of funeral articles

Settori EA - EA Sectors 17 - 29a

Informazioni puntuali e aggiornate circa lo stato
della presente Certificazione sono disponibili
all'indirizzo www.dasa-raegister.com.
Particular and updated information regarding this
Certification is available at www.dasa-raegister.com.

Riferirsi al Manuale Qualità per i dettagli delle
attività svolte e ai requisiti della Norma ISO
9001:2000. La validità del presente Certificato è
sottordinata al rispetto delle prescrizioni del
Regolamento di Certificazione Dasa-Rägister,
dei requisiti della Norma ISO 9001:2000, ed al
programma di sorveglianza annuale e ad un
riferimento ogni tre anni.

Refer to the Quality Manual for details regarding
the activities to ISO 9001:2000 standard
requirements. The validity of this Certificate is
subordinated by a full respect of that prescribed
in Dasa-Rägister Certification Regulation, of
ISO 9001:2000 Standard requirements, to an
annual surveillance programme and to a three
years re-assessment.



S.a.s.

SPAF s.a.s. Via Chieri, 66 - 10022 CARMAGNOLA (TO) - ITALIA

Tel. +39 011.977.15.53 - Fax +39 011.977.15.61

e-mail: spaf@spaf.it - www.spaf.it

ARTICOLI INIETTOFUSI IN ZAMA

finiture: ramato, ottonato antico, ottonato lucido

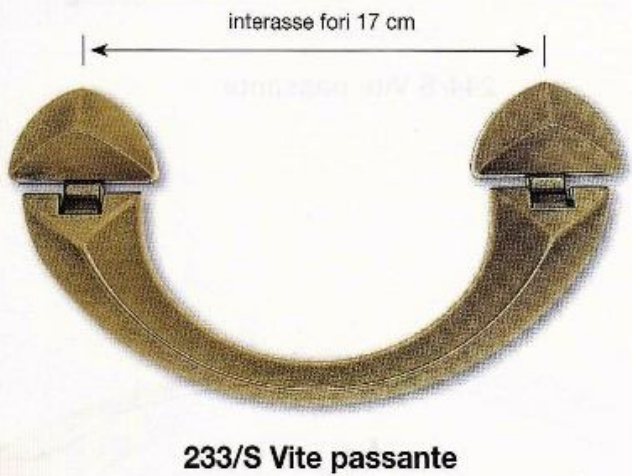

ARTICOLI INIETTOFUSI IN ZAMA

finiture: ramato, ottonato antico, ottonato lucido

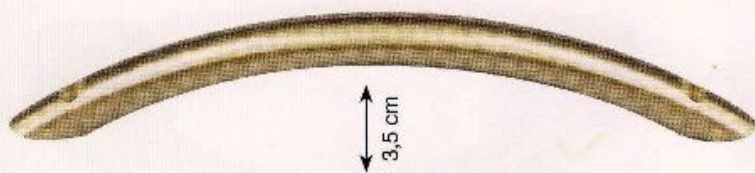

3,5 cm

250/S

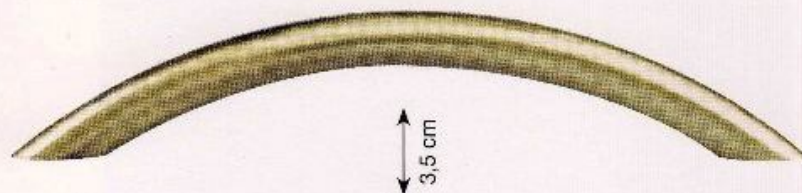

3,5 cm

interasse fori 23 cm

251/S Vite passante

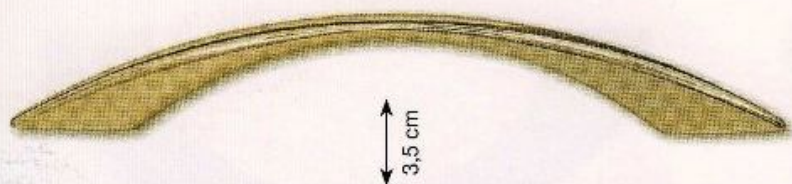

3,5 cm

interasse fori 23 cm

231/S Vite passante

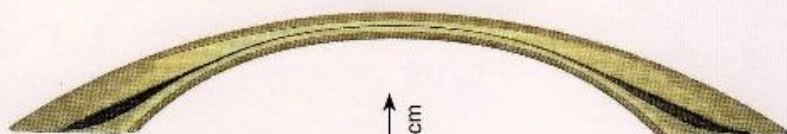

3,5 cm

interasse fori 23 cm

244/S Vite passante

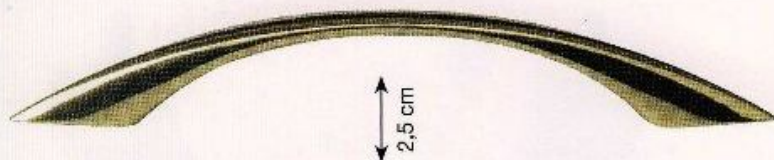

2,5 cm

interasse fori 18 cm

234/S Vite passante

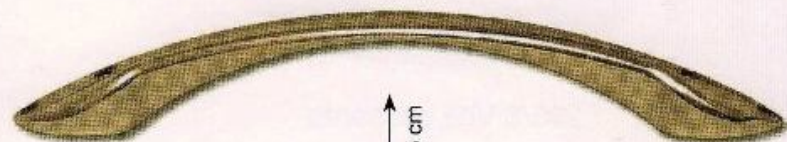

3,5 cm

232/S

BULLONI

per maniglie vite passante



Taglio



Dado



Brugola

ARTICOLI INIETTOFUSI IN ZAMA

finiture: ramato, ottonato antico, ottonato lucido



235/S



245/S

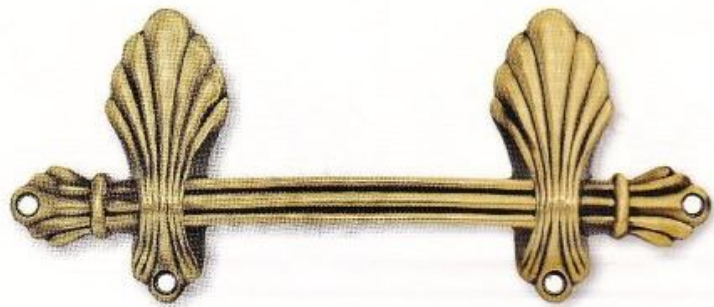

06/E



243/S



240/S

ARTICOLI INIETTOFUSI IN ZAMA

finiture: ramato, ottonato antico, ottonato lucido

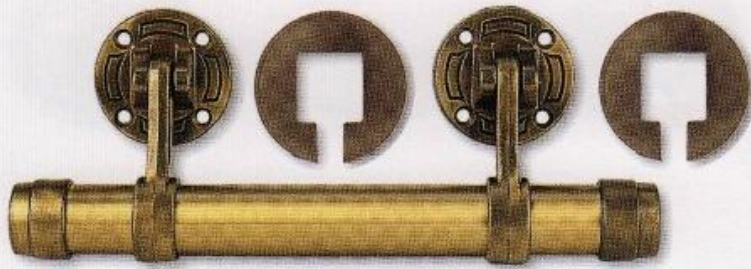

115/S



113/S
Ø 30 - 35

SUPPORTO



POMOLO

115 bis



113/S
bis

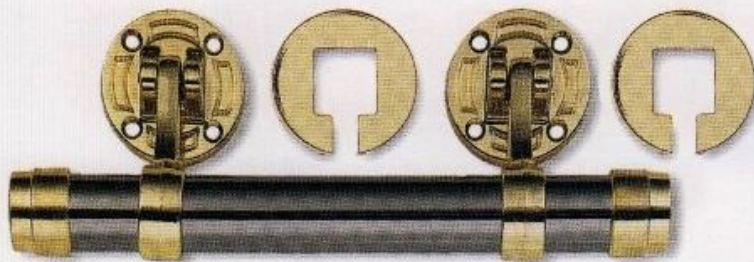
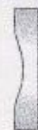

115/S Black Nichel



116/S
Ø 30
vite passante

SUPPORTO



POMOLO

115/S bis

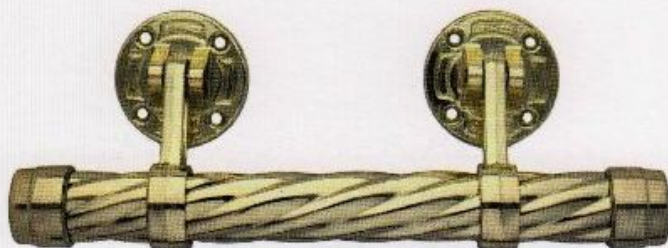

246/S



162/S
Ø 30

SUPPORTO



POMOLO

ARTICOLI INIETTOFUSI IN ZAMA

finiture: ramato, ottonato antico, ottonato lucido

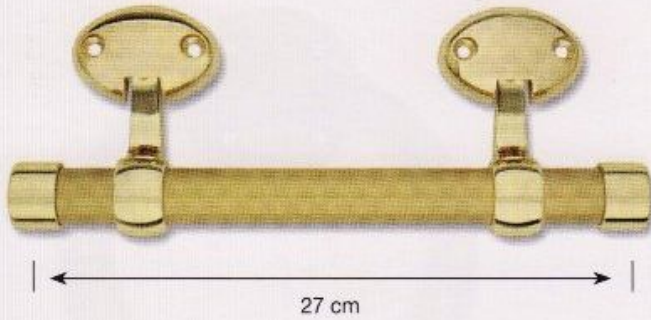

237/S

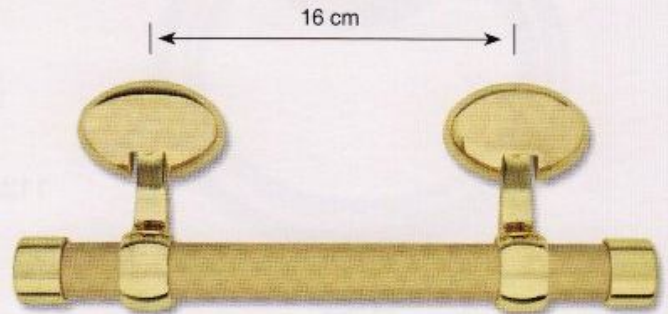

237/SVP
vite passante



109/S

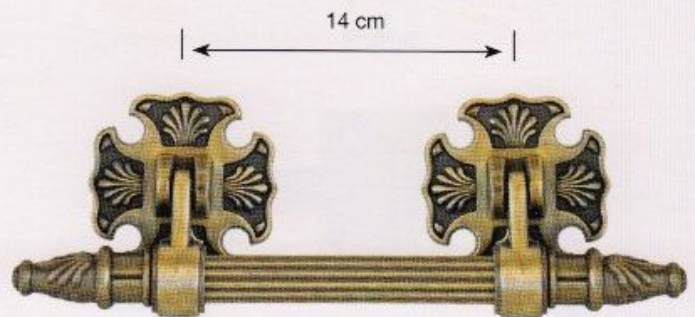

109/SVP
vite passante



106/S cm 30

**COMPLETO PER COFANO
DIRITTO SPALLATO
MISURE A RICHIESTA**



ARTICOLI INIETTOFUSI IN ZAMA

finiture: ramato, ottonato antico, ottonato lucido



112/S

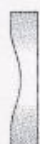

112/S bis



112/S tris



223/S



229/S



229/S bis



224/S



215/SZ INCISA



215/SZ

SUPPORTI



214/S SUPPORTO



120/S TUBOGIRO Ø 8

121/S
ANGOLARI



122/S TUBO ALLUMINIO Ø 8

ARTICOLI INIETTOFUSI IN ZAMA

finiture: ramato, ottonato antico, ottonato lucido



19/S



110/S



012/E

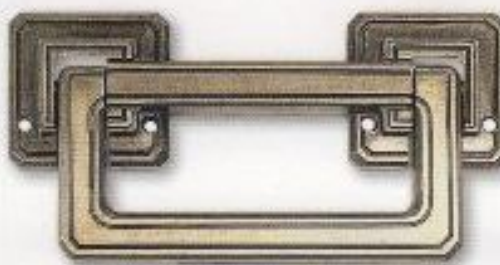

114/S



114/S
bis



239/S Vite passante



58/Z

VITI A CROCE E A FOGLIA



90/S



92/S



93/S



90/P plastica



91/S



94/S

ALZACOPERCHIO



411/S Ø esterno: 4
Ø interno: 2,5



1413/S Ø esterno: 4
Ø interno: 3



1414/S

ARTICOLI INIETTOFUSI IN ZAMA

finiture: ramato, ottonato antico, ottonato lucido

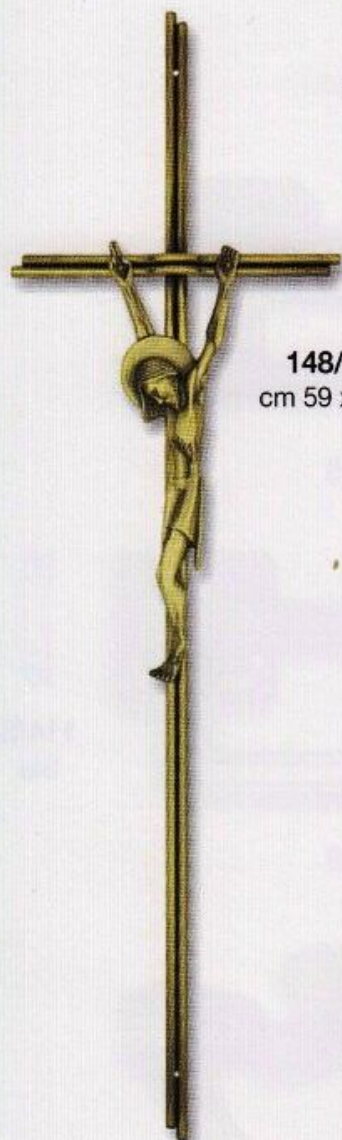

148/S
cm 59 x 18

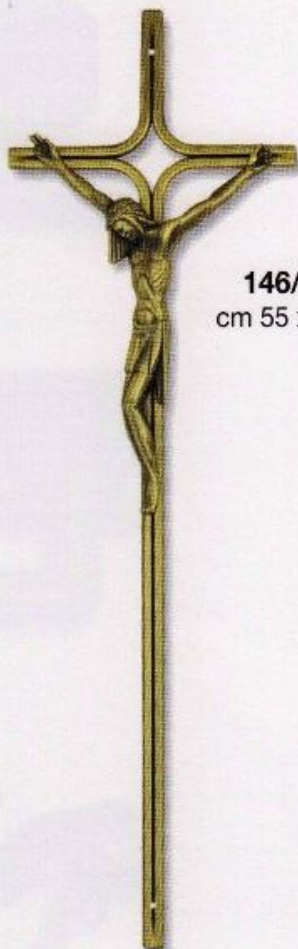

146/S
cm 55 x 17



155/S
cm 56 x 16



158/S
cm 59 x 17,5



153/S
cm 55 x 17



152/S
cm 56 x 16

ARTICOLI INIETTOFUSI IN ZAMA

finiture: ramato, ottonato antico, ottonato lucido

143/S
cm 55 x 17



142/S
cm 55 x 17



36/S
cm 55 x 16



129/S
cm 67 x 16



140/S
cm 55 x 17



38/S
cm 46 x 17,5



ARTICOLI INIETTOFUSI IN ZAMA

finiture: ramato, ottonato antico, ottonato lucido



117/bis
cm 70 x 20



24/S
cm 54 x 18



151/S
cm 48 x 19

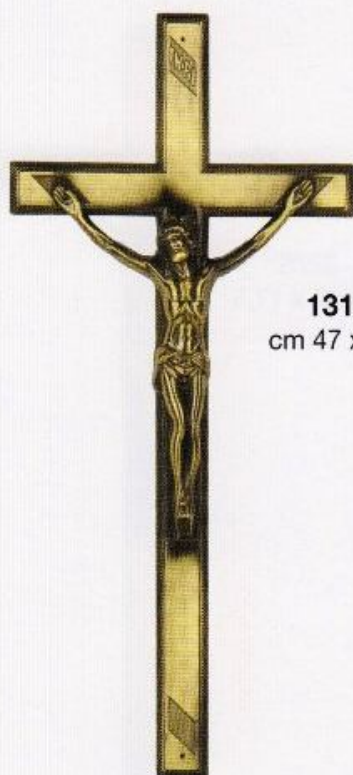

131/S
cm 47 x 21,5



35/S
cm 60 x 15



150/S
cm 67 x 21,5

ARTICOLI INIETTOFUSI IN ZAMA

finiture: ramato, ottonato antico, ottonato lucido

144/S
cm 55 x 17



145/S
cm 56,5 x 15,5



147/S
cm 55 x 17



137/S
cm 70 x 20



130/S
cm 67 x 16



149/S
cm 59 x 18



ARTICOLI INIETTOFUSI IN ZAMA

finiture: ramato, ottonato antico, ottonato lucido



170/S
cm 46,5 x 20,5



159/S
cm 45 x 18



141/S
cm 45 x 18



27/S
cm 39 x 22

ARTICOLI IN LEGNO



020/SL
cm 56 x 16



01/SL
portata 20 Kg



02/SL
portata 20 Kg



03/SL
portata 150 Kg

ARTICOLI INIETTOFUSI IN ZAMA

finiture: ramato, ottonato antico, ottonato lucido



118/S
cm 49 x 14,5



47/S
cm 45 x 16,5



45/S
cm 26 x 11,5



30/E
cm 22 x 17,5



43/S
cm 18 x 14



48/S
cm 17 x 13



46/S
cm 23,5 x 12,5

ARTICOLI PER INFANTI

finitura ottonato lucido



12/E



58/E
cm 22 x 12



59/bis
in ottone
cm 20 x 10



38/E



interasse fori 11 cm - Ø 6 mm

39/E in ottone



94/E



83/S
adesiva e non - cm 10 x 5



880/S
in ottone - cm 8 x 6

SIMBOLI RELIGIOSI



STEMMA
VALDESE



502/S
STELLA DI DAVID
in ottone

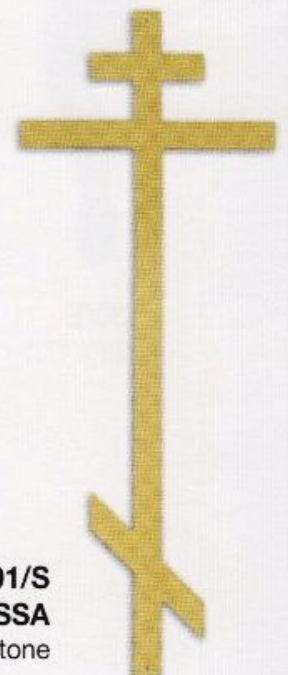

501/S
CROCE ORTODOSSA
cm 52,9 x 18 - in ottone



500/S
MEZZA LUNA E
STELLA MUSULMANA
in ottone

ARTICOLI ACCIAIO

finiture: ramato, ottonato antico, ottonato lucido



3/S



21/S
cm 39 x 19,5



2/S



70/E

PIEDINI

finiture: ramato, ottonato antico, ottonato lucido



55/S
ZAMA



52/S
ACCIAIO



51/S
ACCIAIO



57 bis
ZAMA
cm 8 x 3



57/S
cm 10 x 3
PIEDE PLASTICA
colori: Mogano, Noce

ARTICOLI INIETTOFUSI IN ZAMA

finitura silver

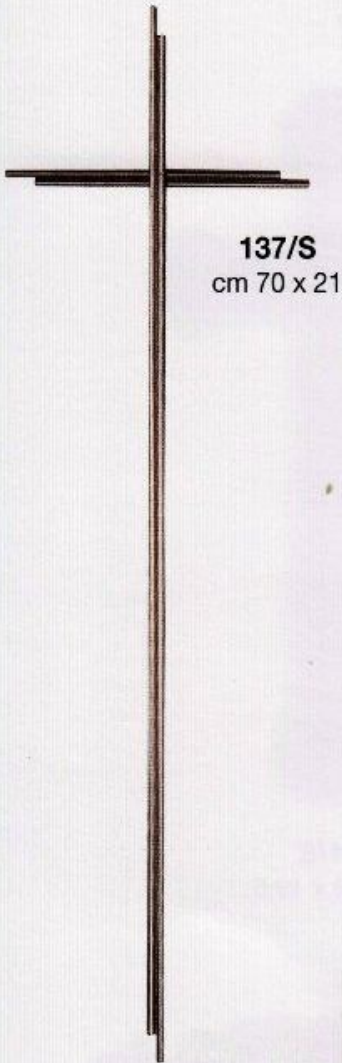

137/S
cm 70 x 21



130/S
cm 67 x 16,5



143/S silver
cm 55 x 17

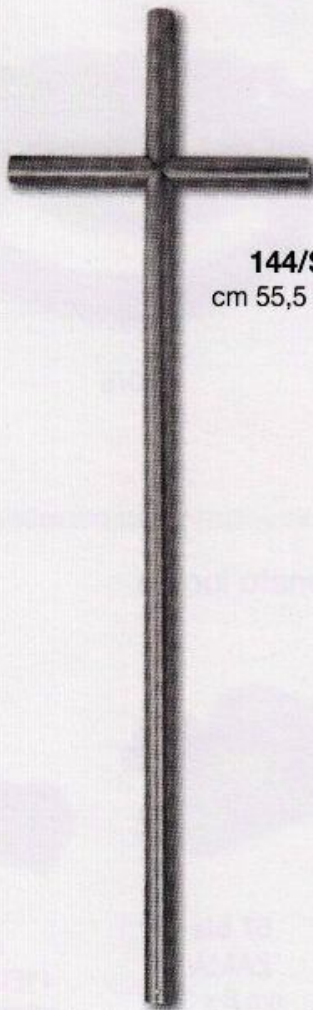

144/S
cm 55,5 x 17

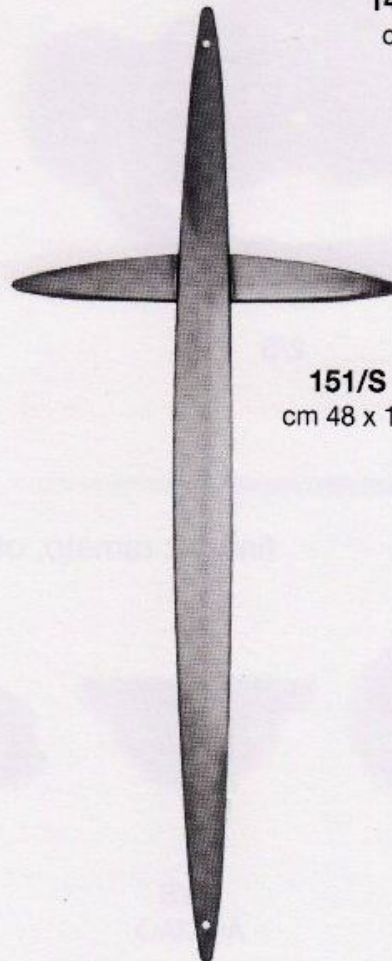

151/S
cm 48 x 19

ARTICOLI INIETTOFUSI IN ZAMA
finitura silver

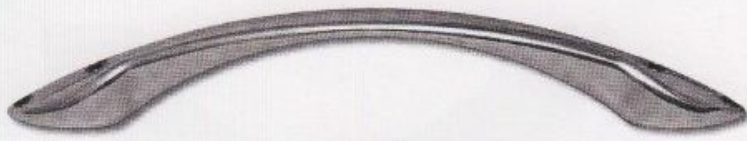

232/S



243/S



225/S

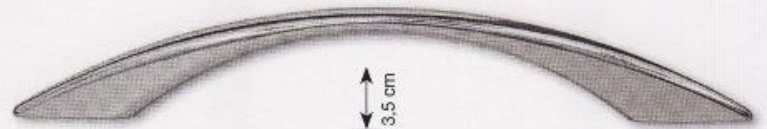

interasse fori 23 cm

231/S



82/S
cm 12,5 x 8



82/bis
cm 12,5 x 8



81/bis
cm 12,5 x 8



85/bis
cm 14,5 x 8,5



85/tris
cm 14,5 x 8,5



407/S



VITE



411/S
ALZACOPERCHIO
Ø est: 4 - Ø int: 2,5



414/S
ORLO OLIVA



417/S
ANELLATO

ARTICOLI PLASTICA

finitura ottonato lucido - a richiesta: ramato, ottonato antico



301/P
cm 48 x 19



300/P
cm 45 x 20,5



302/P
cm 45 x 16,5

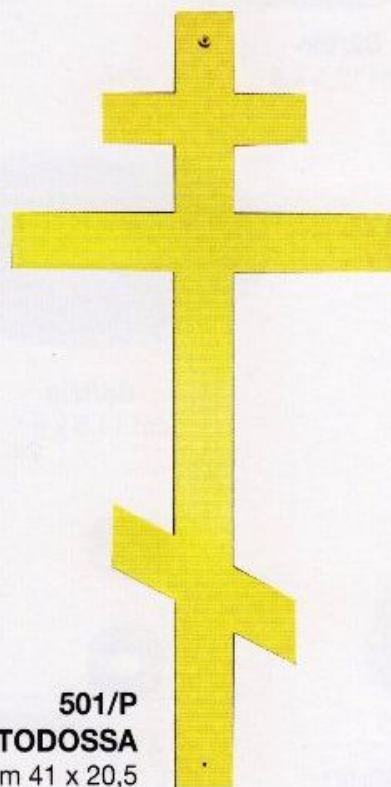

501/P
CROCE ORTODOSSA
cm 41 x 20,5



225/P
portata - load = 220 Kg



235/P
portata - load = 80 Kg



001/P
portata - load = 50 Kg



230/P
portata - load = 140 Kg

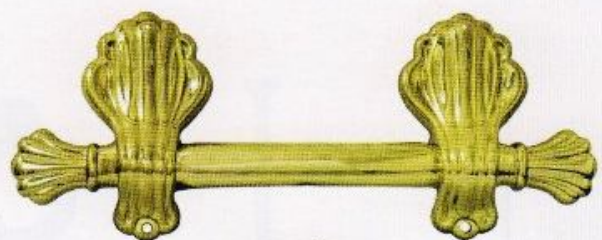

004/P
portata - load = 50 Kg

ARTICOLI IN OTTONE



208/S
Vite passante



207/S



209/S



220/S



220/S
bis



215/S
Incisa



215/S
incisa
bis



236/S

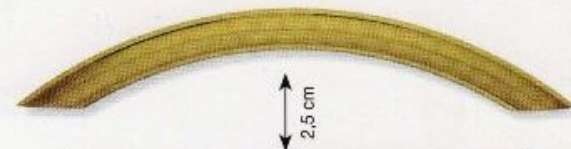

238/S Vite passante



215/S



215/S
bis

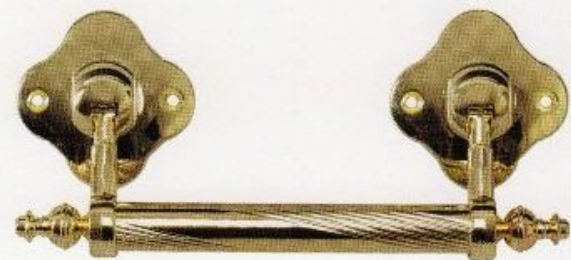

242/S



409/S
Alzacoperchio



interasse fori 23 cm

212/S Vite passante

ARTICOLI IN OTTONE



139/S
cm 54,5 x 18,5



132/S
cm 67 x 17



125/S
con Cristo
cm 57 x 16,5



135/S
cm 59 x 20,5



138/S
cm 67 x 21,5



26/S
cm 66 x 16

ARTICOLI IN OTTONE

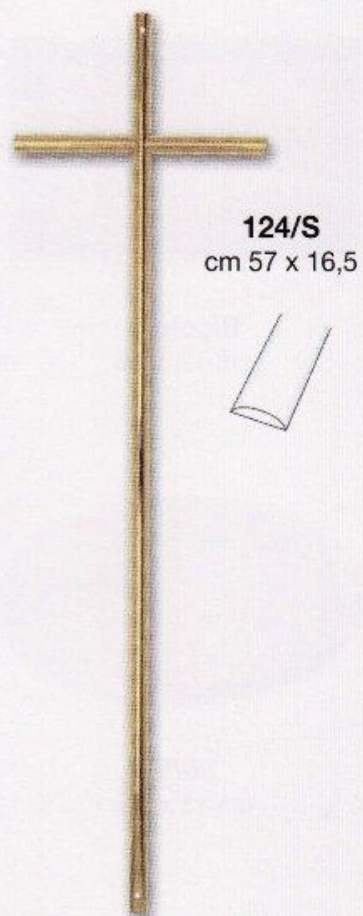
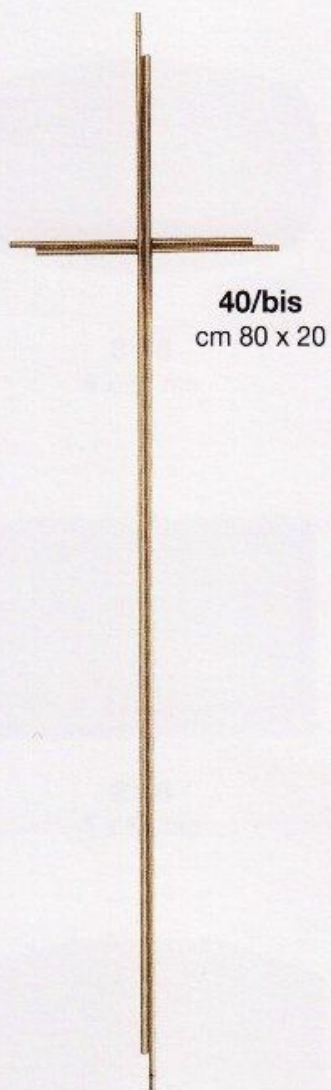
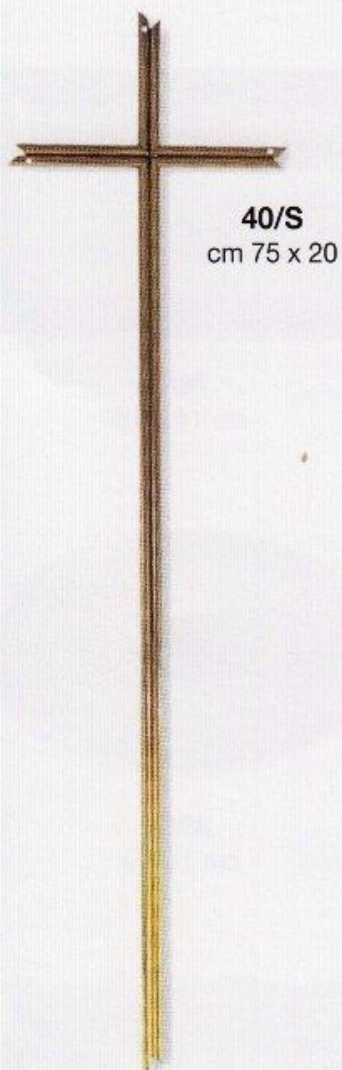

TARGHE E CORNICI IN OTTONE



Bicolore
cm 12,5 x 8



87/S
cm 13 x 8

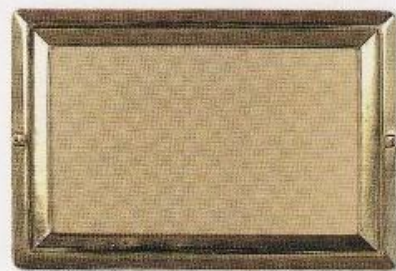

76/S
cm 14 x 9,5



85/S
cm 13 x 8,5



86/S
cm 12 x 7



88/S
cm 14 x 9



89/S
cm 13 x 9



92/S
cm 13 x 8



93/S
cm 13 x 8

TARGHE MULTISTRATO GRAFLUX



95/S
adesiva - cm 12,5 x 8



96/S
adesiva - cm 15,5 x 9



97/S
adesiva - cm 14,5 x 8,5

Le targhe in multistrato sono adatte per l'incisione in quanto asportando con la fresa per pantografo il primo strato colore oro, l'incisione apparirà nera che è il colore del secondo strato. Particolarmente apprezzate per uso esterno. Spessore 1,5 mm - colore oro con bordo nero.

TARGHE

finiture: rame, ottone, nero, ecc...



98/S
oro lucido - cm 14,5 x 8,5



85 bis
cm 14 x 8,5



103/FA
cm 15 x 10



74/S - cm 12 x 8,5
adesiva e non ottonata



80/S
cm 15 x 9



80 bis
cm 15 x 9

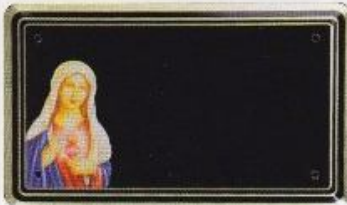

81/S Madonna
cm 15,5 x 9



81/S Padre Pio
cm 15,5 x 9



81/S Cristo
cm 15,5 x 9



78/S
adesiva e non - cm 15,5 x 9



81/S
cm 15,5 x 9



99/S
oro lucido - cm 12,5 x 8

79/S
adesiva e non
cm 7 x 2,5



83/S
adesiva e non
cm 10 x 5



75/S
cm 14 x 9,5



72/S
cm 17 x 11



70/S
cm 16,5 x 15

TARGHE RADICA



75/S RADICA



82/S RADICA
adesiva e non - cm 12,5 x 8



881/S BLU



881/S RADICA

TARGHE

finitura: rame, ottone, nero, ecc...



82/bis



882/S - cm 12,5 x 8



883/S - cm 14,5 x 8,5



77/S Black Nichel
cm 12,5 x 8



82/S
adesiva e non - cm 12,5 x 8



73/S
adesiva e non - cm 12,5 x 8

bordi alternativi per targa 82/S con fori



bordo Slovenia



bordo Croazia



bordo Grecia

ARTICOLI VARI



430/S BARRIERA FIX



427/S BARRIERA



**426/S
MATERASSINO BIOASSORBENTE**



**424/S
SACCO da recupero 6 maniglie**



**425/S
SACCO JUTA - SPEDIZIONE AEREA
Mod. A diritto - Mod. B spallato**



**428/S
SACCO LUSO - SPEDIZIONE AEREA**



**429/S
SACCO ELASTICIZZATO - SPEDIZIONE AEREA**



POLVERE ASSORBENTE



LENZUOLINO NYLON



LENZUOLINO BIO

ARTICOLI VARI



DEPURATORE SPAF



DEPURATORE



TUTA



CORONA ROSARIO



PUNTA PANTOGRAFO



ANNERITORE



GUANTI

MENTONIERE



Mentoniera BIO
Misure: S - L



FERMA OCCHI



A



B



C



D

ARTICOLI VARI



SALDATORE



**BRUCIATORE
PER CERALACCA**



**MAZZETTA
LONG LIFE**



MAZZETTA



SPANDI ACIDO



ACISALD - 1 Kg



SIMPLEFIX - 25 ml



BOMBOLA GAS



CERALACCA



VERGHETTA STAGNO 50%



SALDATORE A FREDDO

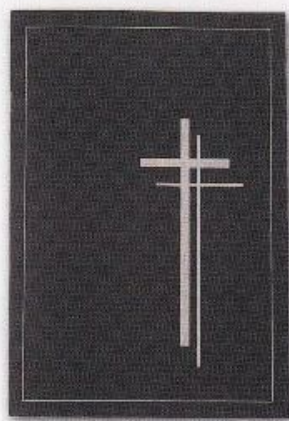

LIBRO FIRMA NORMALE



LIBRO FIRMA SOFTEN

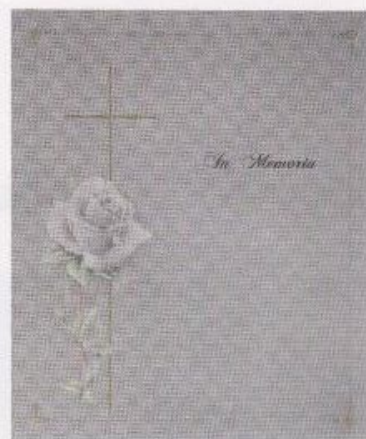

LIBRO FIRMA ROSA

MINUTERIE



402/S
Ø 24
BULLETTE LISCE



403/S
Ø 10



404/S
Ø 10
LAVORATA



401/S Ø 24
CAPPELLO
PRETE



407/S
CHIODO
14 x 25



417/S
ANELLATO



413/S
ORLO OLIVA
TORNITO



414/S
ORLO OLIVA



415/S
ORLO
LENTICCHIA



416/S
ORLO FIORE



COPRIVITE A 3 PUNTE



405/S MARGHERITA



406/S LISCIO



400/S
TORNITO

MISURE VITI	
svasata	borbata
4,5 x 30	•
4,5 x 35	•
4,5 x 40	•
4,5 x 45	•
4,5 x 50	•
4,5 x 60	• •
4,5 x 70	•

DISPONIBILI IN MAGAZZINO VITI AUTOFILETTANTI CON TAGLIO A CROCE DI VARIE DIMENSIONI

COFANETTI PER ESUMAZIONE IN ZINCO E ZINCATO

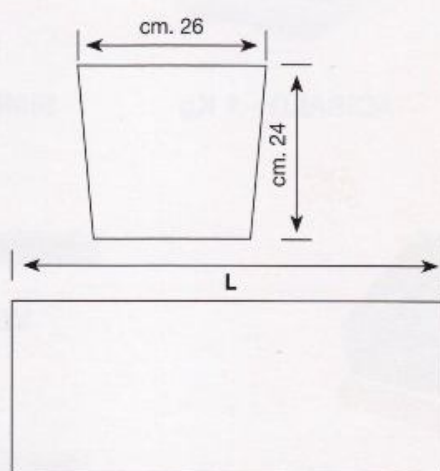
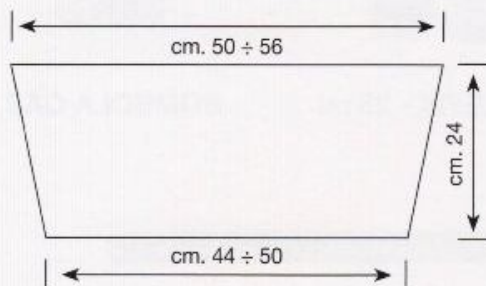

TIPO ZINCATO

Confezione da 10 pezzi

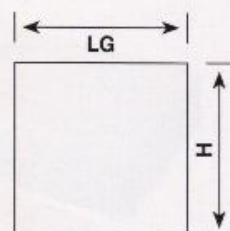

- Tipo A cm. 50 x 25 x 23
- Tipo B cm. 56 x 25 x 24
- Tipo C cm. 60 x 25 x 23
- Tipo D cm. 62 x 27 x 27
- Tipo E cm. 70 x 22 x 22
- Tipo F cm. 40 x 20 x 20
- Tipo TO cm. 65 x 29 x 17

CASSONI DI ZINCO

Lunghezza 208 mm - Larghezza 68 mm - Altezza 48 mm

URNE



418/S

URNA BRONZO LISCIA CON ZINCO Lt. 4



419/S

URNA BRONZO MANI CON ZINCO Lt. 4



420/S

URNA BRONZO FIORE CON ZINCO Lt. 4



423/S NERA



423/S RAME



423/S RADICA

URNE



422/S URNA LEGNO - CON ZINCO - Lt. 5



421/S URNA LEGNO - CON ZINCO - Lt. 5



435/S URNA IN LEGNO INTARSIO
CON ZINCO - rovere - Lt. 4



436/S URNA IN MEDIUM DENSO
CON ZINCO - radica - Lt. 4



437/S URNA IN LEGNO INTARSIO
MADREPERLA CON ZINCO - blu - Lt. 4



438/S URNA IN MEDIUM DENSO
CON ZINCO - noce - Lt. 4



431/S URNA IN ECO ACCIAIO CON SACCHETTO
grigio chiaro martellato - Lt. 4,5



432/S URNA IN ECO ACCIAIO CON SACCHETTO
bianco - Lt. 4,5

COPRITAVOLI E TAVOLI FIRMA



606/S
velluto microfibra

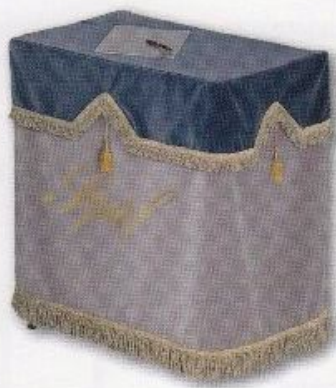

608/S
velluto bicolore microfibra



609/S
velluto microfibra



612/S OVALE
cm 70 x 55 x 80 h



612/S RETTANGOLARE
cm 70 x 55 x 80 h

PORTA MANIFESTI



622/S
forma a richiesta



620/S



621/S

PORTA MANIFESTI IN TESSUTO

Spazio utile locandina

cm 70 x 50
cm 50 x 35
cm 42 x 29,7
cm 29,7 x 21
cm 23 x 16



623/S

CATAFALCHI

È costituito interamente in tubolare di acciaio piegato a sezione tonda e quadra e può richiudersi dopo l'uso, rendendo così l'ingombro minimo e facilitando il trasporto. È completo di fiamme in plastica o in vetro su coni portafiaccola ed ha croci laterali e pax centrale. Viteria in ottone. Munito di piedini regolabili. L'impianto elettrico incorporato nei bracci del telaio e a norme CEI ed ENPI perciò dotato di trasformatore: V 220 - V 12 - W 70.

A) In tubo tondo con portafiaccola in ottone a forma sferica e fissaggio fiaccola per avvvitamento che caratterizza il tipo lusso. A richiesta è disponibile anche con ruote con e senza freno.

Dimensioni:

lunghezza: cm. 105 (chiuso), larghezza cm. 74 (aperto), lunghezza cm. 156 (aperto), altezza cm. 58, peso kg. 18.



A



B

B) Costruito in tubo tondo, raggruppa in se le caratteristiche del catafalco e del portabara avendo, da un lato due bracci estensibili per mezzo della fisarmonica con due fiamme fissate per avvvitamento, dall'altro termina con un supporto portacassa. È dotato di piedini registrabili con tampone in gomma ed è corredato di valigia in similpelle color marrone con manici.

L'impianto elettrico è severamente protetto, lampada mignon. *Dimensioni:* lunghezza cm. 50 (chiuso), larghezza cm. 23 (chiuso), larghezza cm. 80 (aperto), lunghezza cm. 153 (aperto), altezza cm. 53, peso kg. 12.



C

C) In tubo tondo con piedini registrabili e dadi saldati, a richiesta con ruote in gomma piroettanti della portata complessiva di kg. 250 con o senza freno di bloccaggio.

Dimensioni: lunghezza cm. 88 (chiuso), larghezza cm. 14 (chiuso), lunghezza cm. 133 (aperto), altezza cm. 53, peso kg. 12.

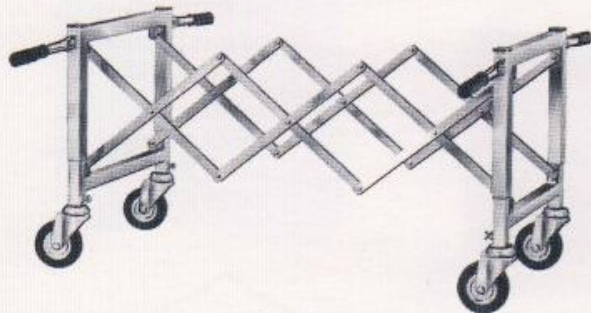

In tubo quadro a fisarmonica con impugnature laterali ripiegabili, munito di ruote in gomma piroettanti della portata complessiva di kg. 250. A richiesta freno di bloccaggio.

Dimensioni: lunghezza cm. 12 (chiuso), larghezza cm. 51 (chiuso), lunghezza cm. 101 (aperto), altezza cm. 64 (chiuso), altezza cm. 46 (aperto), peso kg. 12.

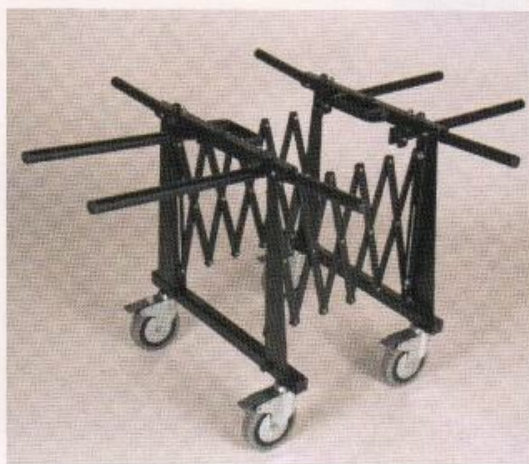

REGGIBARA A FISARMONICA n. 8 maniglie

N. 4 impugnature laterali + n. 4 impugnature frontali

Maniglia centrale per il trasporto

Bloccaggio sicurezza anti chiusura

Verniciatura a polvere nera

Dimensioni aperto cm. 140 x 50 x 47 altezza ruote escluse

Dimensioni chiuso cm. 16 x 50 x 47 altezza ruote escluse

N. 4 ruote Ø 150 mm, piroettanti, con freno.

IL NUOVO MINIFRIGO OLIVETTI



Dimensioni e peso del coperchio lato testa:

Lunghezza	mm	1100
Larghezza	mm	794
Altezza	mm	182
Peso	kg	19,500

Dimensioni e peso del gruppo frigorifero:

Lunghezza	mm	487
Larghezza	mm	275
Altezza	mm	455
Peso	kg	26,200

Caratteristiche elettriche del motore:

Tensione nominale	V	230/1/50
Corrente	A	2,06
Potenza assorbita	Watt	275
Potenza motoreHP		0,25
Temperatura interno	bara	-10° C

Dimensioni e peso del coperchio lato piedi:

Lunghezza	mm	1100
Larghezza	mm	780
Altezza	mm	150
Peso	kg	16,300

Dimensioni utili:

Lunghezza	mm	2150
Larghezza	mm	720

Pratico, silenzioso, leggero ed ergonomico l'apparecchio refrigerante della Olivetti studiato ad arte per offrire le migliori soluzioni agli impresari. Il gruppo comandi motore si trova in posizione ribassata (in modo da scomparire dietro al cofano) e l'altezza del copriferetro è ridotta ai minimi termini, tale da favorire la visuale dell'interno (favorita anche dalla presenza di una lampada). Grande superficie vetrata. La parte inferiore del copriferetro si adatta ad ogni tipo di cofano, spallato o a sarcofago, nelle più diverse misure. Le operazioni di montaggio e di trasporto del frigo possono essere effettuate da un solo operatore, è divisibile in tre parti e ognuna di essa trova posto nelle comode sacche alloggiabili nel baule di una semplice berlina. Recupero della condensa, raccolta al momento dello spegnimento del frigo attraverso un sistema a tenuta stagna.



Il nuovo carrello in acciaio al carbonio per la movimentazione dei cofani facilita tutte le fasi del trasporto, sia per salire sia nello scendere, anche nei passaggi più pericolosi e complessi, con in più tutte le innovazioni che la recente tecnologia ha messo a punto perchè nulla sia trascurato nel campo della sicurezza. Il rivoluzionario sistema di frenaggio brevettato e il sistema di controllo delle fasi di discesa col riconoscimento automatico dell'interruzione dei gradini garantiscono la perfetta esecuzione di tutte le operazioni di trasporto del cofano.

SCOIATTOLO, IL SALISCALE



Dimensioni

Altezza	150 cm
Larghezza	53 cm
Profondità	55 cm

Motore

Elettrico da 220 V
Trasformatore a norme CE da 150 W - 220/12 V



CASSONE RECUPERO IN ACCIAIO INOX

PANTOGRAFO OLIVETTI 3 PISTE



MATER-BI IL BIODEGRADABILE AL 100%



103 MB



01 MB



57 MB



Portata 350 Kg



36 MB



41 MB



305 MB

Accessori per cofani in Mater-Bi biodegradabili al 100%. La ricerca tecnologica evoluta in questi anni permette oggi alla SPAF, da tempo azienda leader nella produzione di accessori per cofani, di offrire una nuova gamma di maniglie portanti, crocefissi, targhe e piedini biodegradabili al 100% in Mater-Bi, aerobicamente ed anaerobicamente idonei all'incenerimento (CREMAZIONE), già autorizzati dal Ministero dell'Ambiente e Ministero della Sanità n. l. 400.4/9N167 del 1° febbraio 1997.

I modelli sono disponibili nelle colorazioni oro, rame, marrone martellato e Mater-Bi naturale.

ARTICOLI A RICHIESTA INIETTOFUSI IN ZAMA

finiture: ramato, ottonato antico, ottonato lucido



8/S



011/E



12/S



14/S



15/S



17/S



18/S



28/E



107/FA

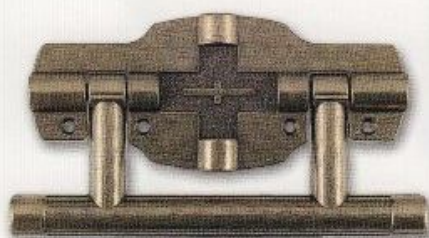

49/Z



108/FA



111/S



103/E



103/bis



16/S

ARTICOLI A RICHIESTA INIETTOFUSI IN ZAMA

finiture: ramato, ottonato antico, ottonato lucido



33/S
cm 50 x 20,5



32/S
cm 50 x 20,5



17/E
cm 35 x 18,5



22/E
cm 39 x 18,5



17/Z
cm 50,5 x 20,5

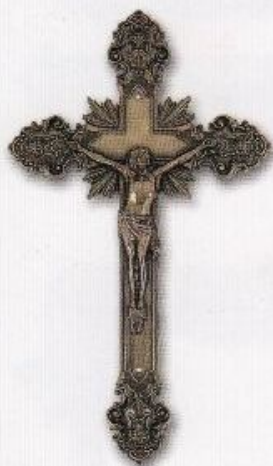

28/S
cm 40 x 23



29/S
cm 37 x 19



34/S
cm 47 x 20



25/S
cm 41,5 x 20,5



30/S
cm 50 x 29



210/SZ



11/S NON PORTANTE



9/S NON PORTANTE



101/FA

I prodotti **SPAF** illustrati sono normalmente prodotti in zama e acciaio galvanizzati nei colori: • rame brunito • ottone brunito • ottone lucido • nichel • peltro.

Ottone finito a mano, verniciato a fuoco.

Tutti gli articoli sono trattati con vernici antiossidanti.

Les articles **SPAF** ici présentés sont généralement produit en **zamak** et **acier** galvanisés dans les couleurs: • vieux cuivre • vieux laiton • laiton poli • nickel • étain.

Laiton fini a la main.

Tous les articles sont traités avec des vernis antioxydants.

The **SPAF** illustrated products are made, usually, by **samak** and galvanized **steel** in the colours: • dark copper • dark brass • bright brass • nickel • pewter.

Brass is hand finished.

All our articles are treated with antirust paint.

Die in **SPAF** illustrierten Produkte werden normalerweise aus **Zamac** und **Stahl** galvanisiert, in den Farben: • Alt-Kupfer • Alt-Messing • Messingglanz • Nickel und Hartzinn hergestellt.

Reines Messing mit manueller Bearbeitung.

Die ganze Produktion wird mit Rostschutzlack lackiert.

Иллюстрируемые изделия **SPAF** производятся, как правило, из цинка и стали оцинкованной в цветах: • медь полированная • латунь полированная • латунь глянцевая • никель • олово.

Латунь доработанная вручную.

Все наши изделия имеют противокислительную окраску.



SPAF s.a.s. Via Chieri, 66 - 10022 CARMAGNOLA (TO) - ITALIA

Tel. +39 011.977.15.53 - Fax +39 011.977.15.61

e-mail: spaf@spaf.it - www.spaf.it

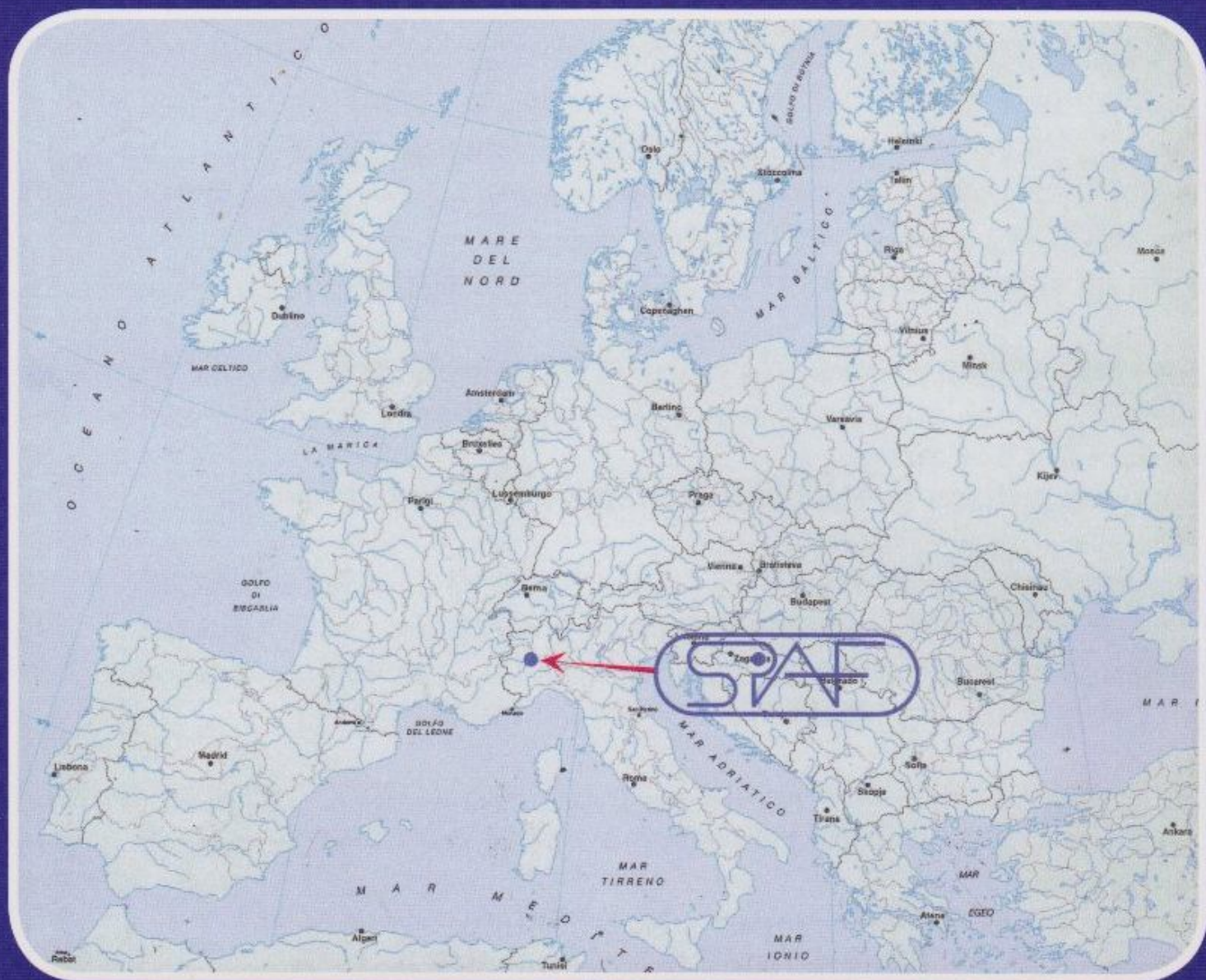

SPAF s.a.s. Via Chieri, 66 - 10022 CARMAGNOLA (TO) - ITALIA
Tel. +39 011.977.15.53 - Fax +39 011.977.15.61
e-mail: spaf@spaf.it - www.spaf.it